



a free guide to
PENCIL SHADING
TECHNIQUES *for*
beginning artists



TABLE *of* CONTENTS

A Free Guide to Pencil Shading Techniques for Beginning Artists

■ Shading the Sphere: How to Shade Drawings Effectively (<i>Drawing</i> , Spring 2010)	3
■ Drawing Board: Modeling Complex Form by Sadie Valerie (<i>The Artist's Magazine</i> , November 2013)	11
■ Excerpt from <i>The Drawing Bible</i> by Craig Nelson	14
■ Excerpt from <i>Drawing With Your Artist's Brain</i> by Carl Purcell.	25
MORE RESOURCES	33

Shading the Sphere

Depicting light and shadow are essential to creating the illusion of three-dimensional space when drawing subjects such as spheres, ovoids, and the human figure.

—
by **Jon deMartin**

Correctly depicting how light falls on forms is essential to a realistic drawing. The previous article in this series covered how to model values and gradations on the cylinder, which curves in one direction. Combining two cylinders—one on a horizontal axis and one on a vertical axis—gives us double curvature. (See Illustration 1.) This article discusses how to draw value on the two basic geometric solids that curve in two directions: the sphere and the ovoid. (See Illustration 2.)

Spheres and ovoids underlie many natural forms, including subjects crucial to a draftsman, such as the human head. The surfaces of most objects found in nature are complex, irregular, and so unpredictable that they can easily overwhelm us. However, when artists understand the inherent characteristics of these geometric solids, they are in a better position to perceive and draw natural forms effectively.

How Light Affects Value on a Sphere

The sphere is the purest example of a double-curved geometric solid. It is perfectly round, and no matter where you hold it in space its shape never changes. Every part of a sphere is equally curved, and all points of its surface are equidistant from its center. Only a flat plane, such as a side of a cube, can be shaded an even value. Curving and rounding forms always produce the effect of graduated values. The sphere is the most powerful example of this, so we'll use it as the foundational example for modeling the surfaces of double-curved forms.

It's useful to know why gradations appear the way they do. When looking at a curved form, how many gradations can

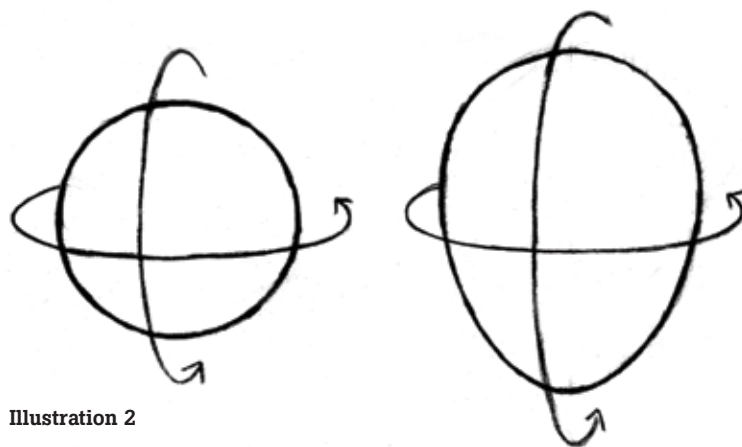
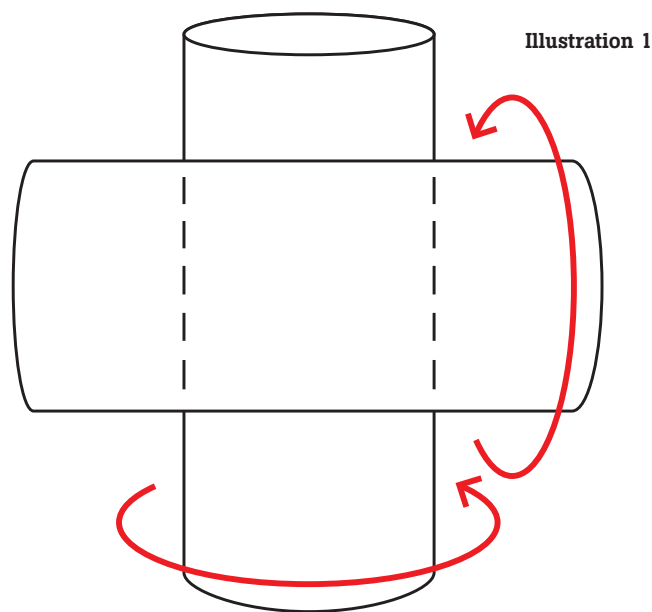
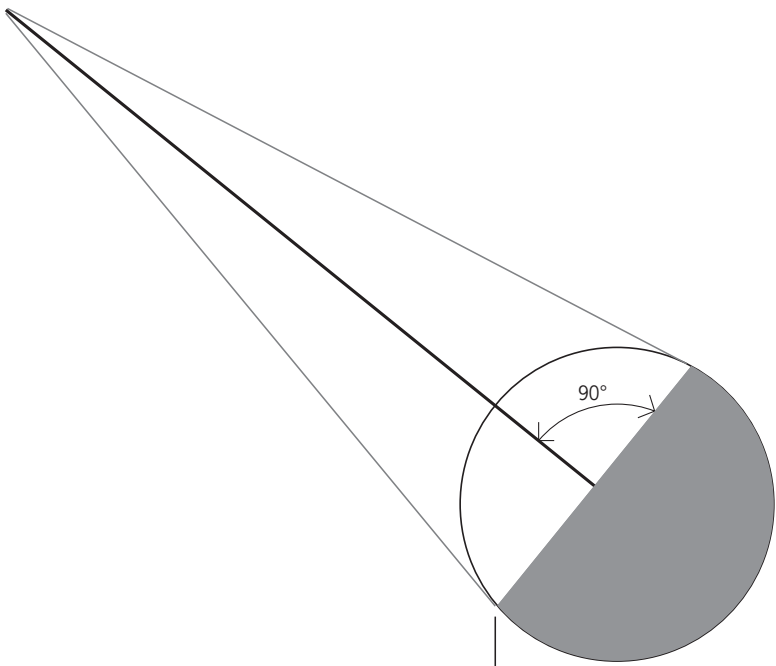
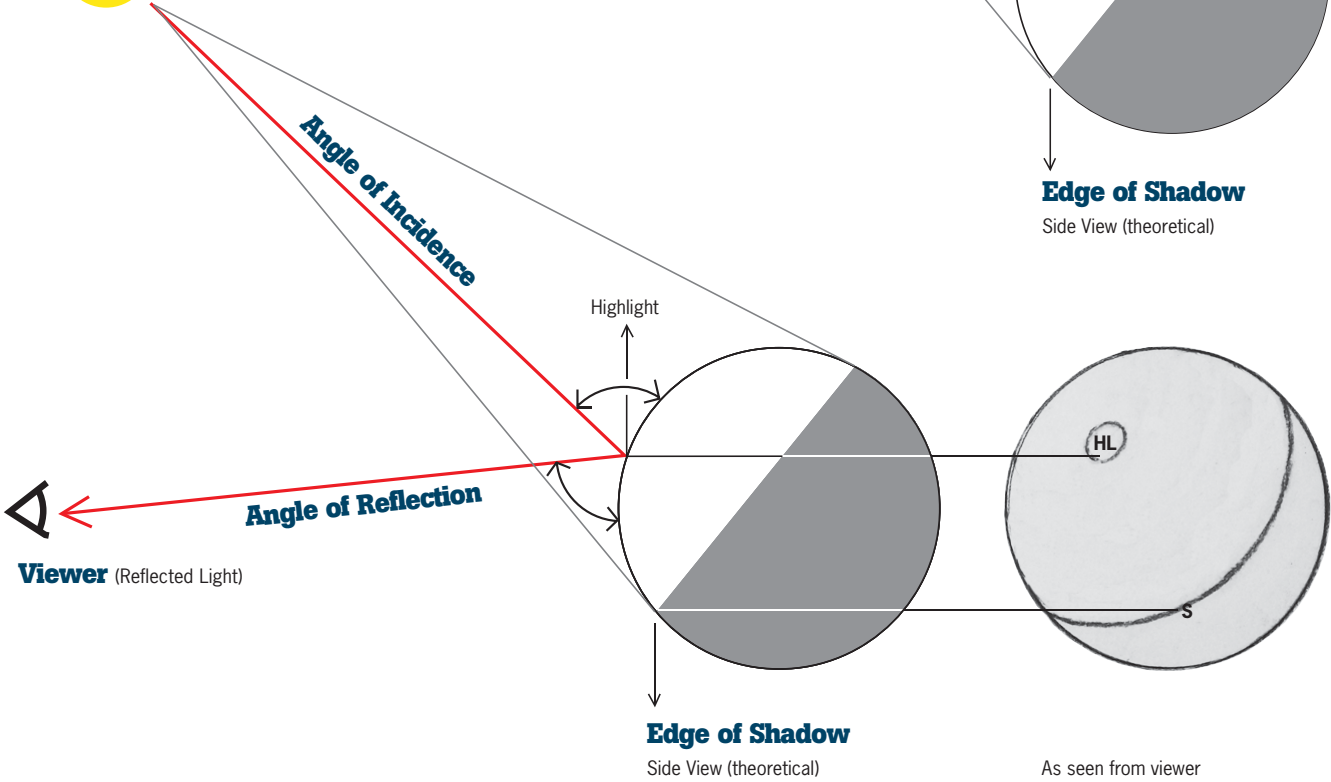

Illustration 3



Edge of Shadow
Side View (theoretical)

Illustration 4



Edge of Shadow
Side View (theoretical)

As seen from viewer

we see? Most artists can tell you they see two, the shadow and the highlight. Not only are these the most visible gradations but they are also the most important to identify. As Illustration 3 shows, the dividing line between light and shade on a sphere is perpendicular to the direction the light comes from. The edge of the shadow indicates the exact point where the light ends (or where the light source can no longer reach). All shadows are the result of something blocking the light.

As Illustration 4 shows, a highlight occurs at the spot on an object at which the angle of the light source (which is incident light, hitting

the surface of the object directly) is equal to the angle of reflectance (at which the light reflects to the eye). In other words, the highlight is the most direct path from the light source to the object and then to the viewer. It's the brightest of all the lights. Depending on the form's surface, the highlight may be more or less pronounced than on other surfaces. For instance, a highlight on the glossy surface of a billiard ball will reflect more light than a highlight on the matte surface of a tennis ball.

Illustration 5 shows all the gradations that are necessary to give form its three-dimensional illusion. These gradations are called

Illustration 5

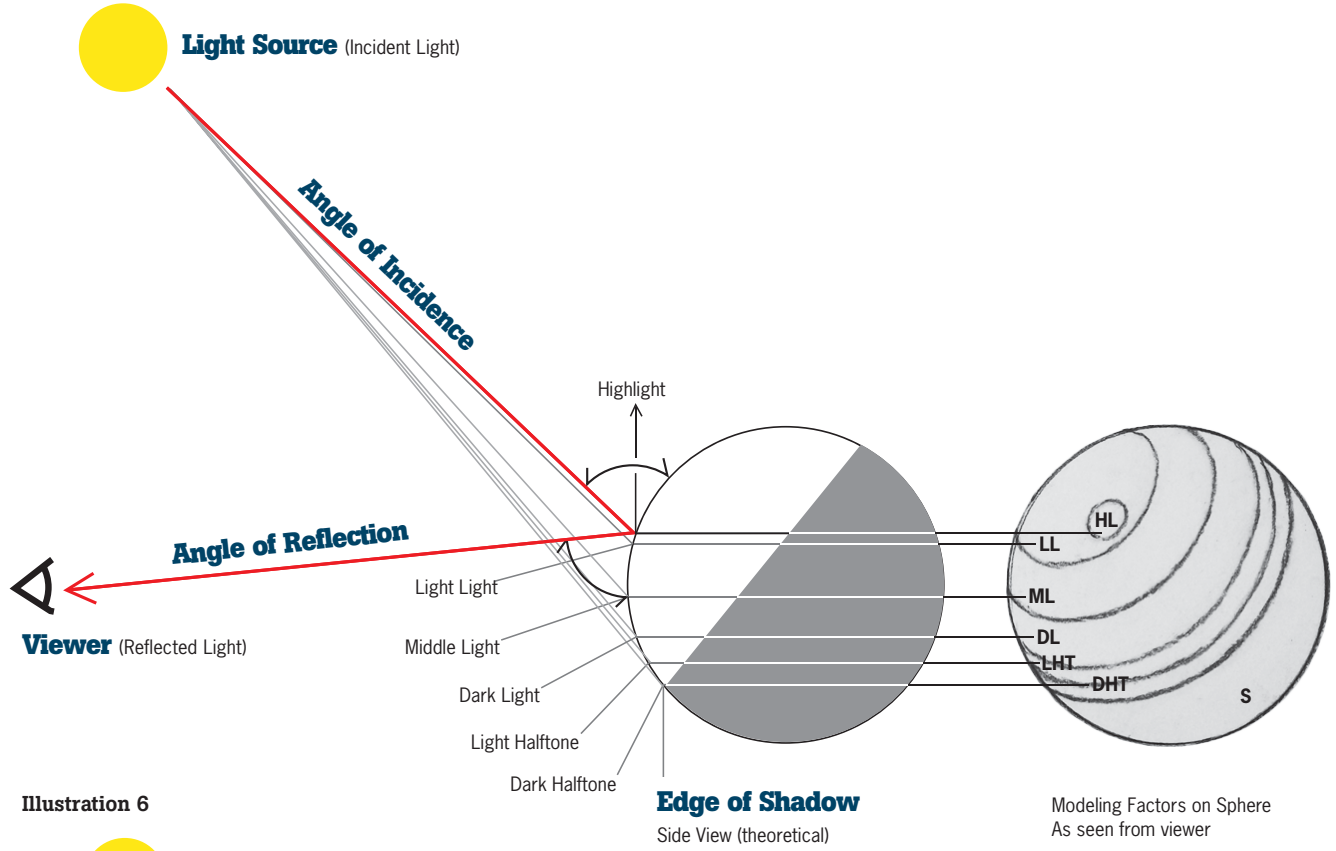
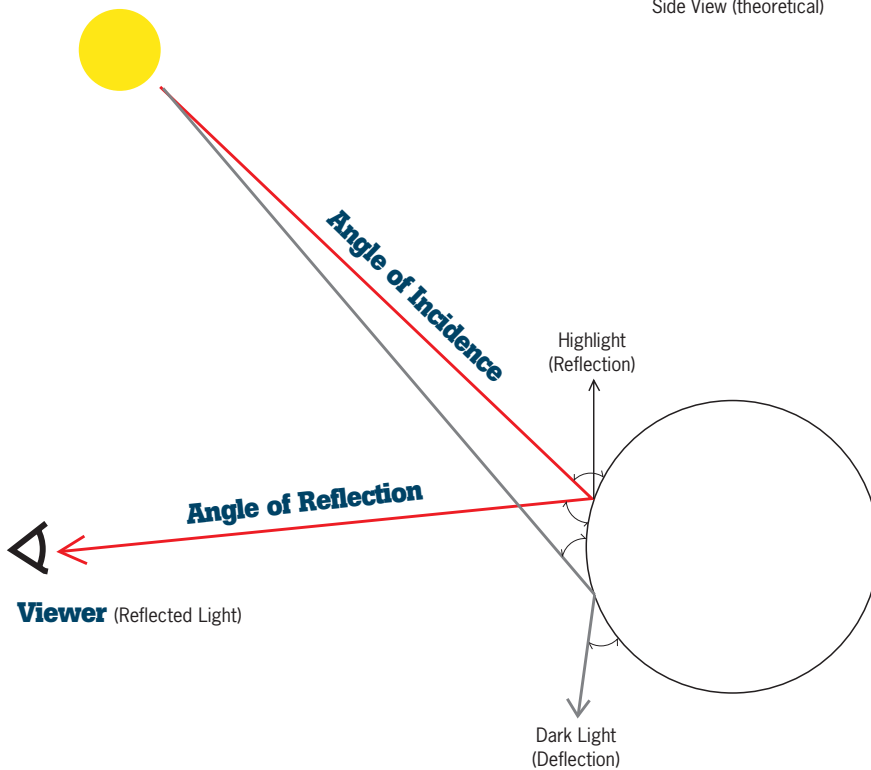
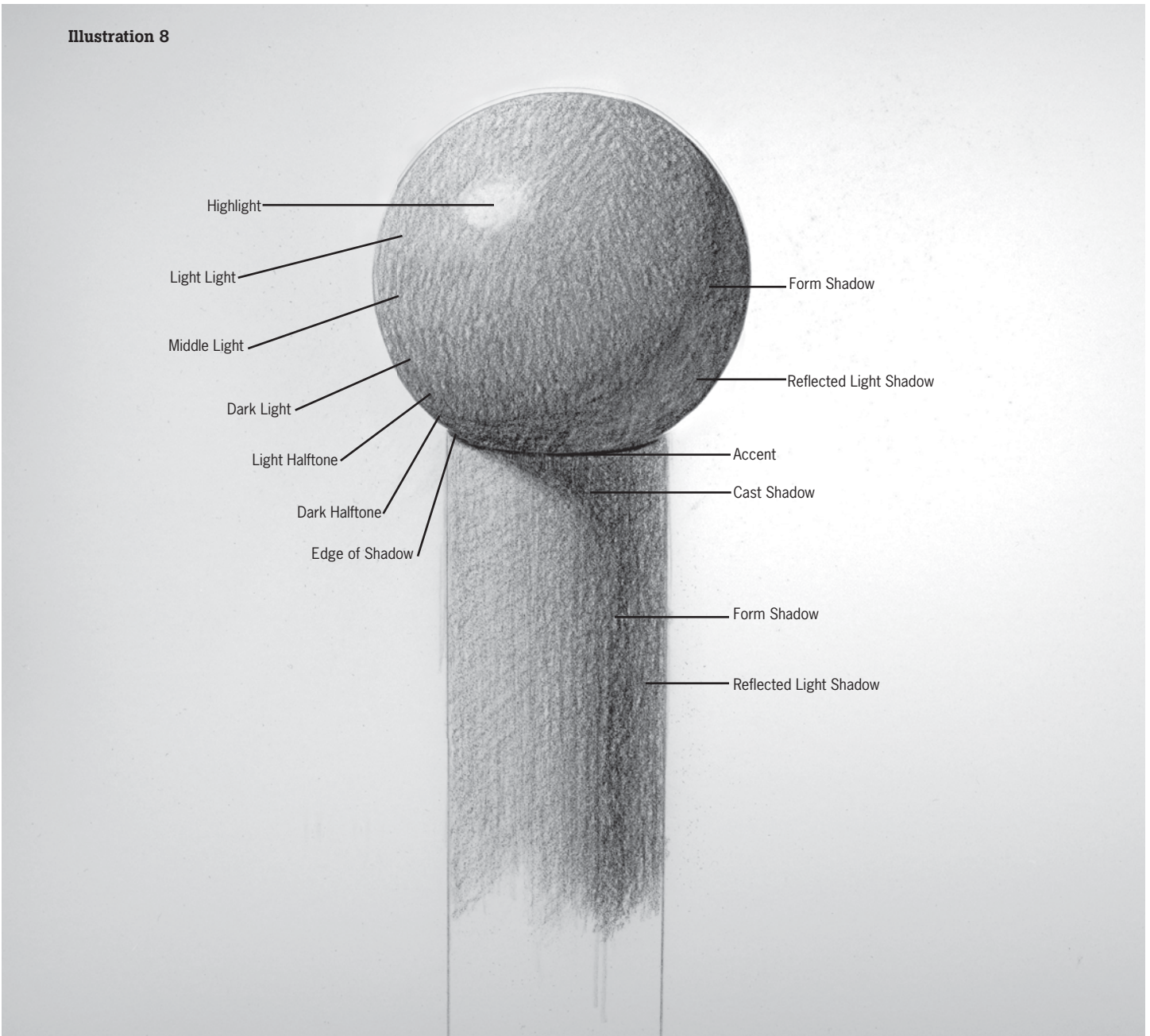
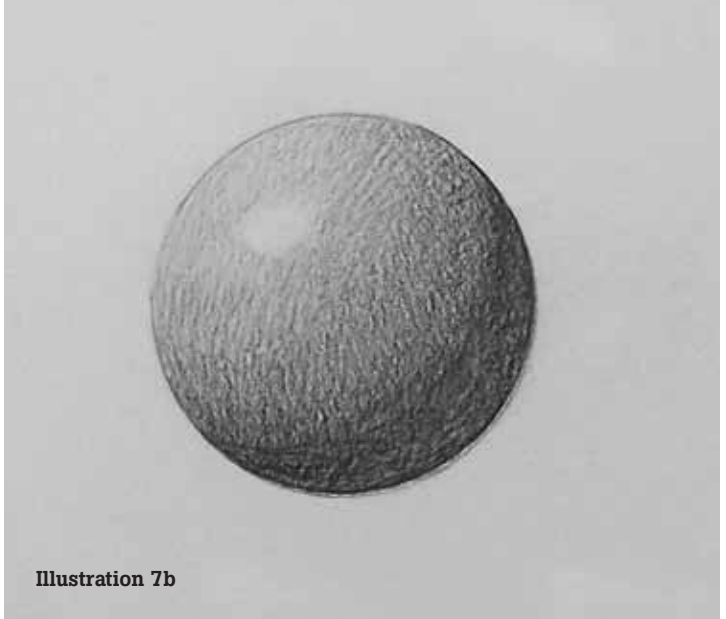

Illustration 6





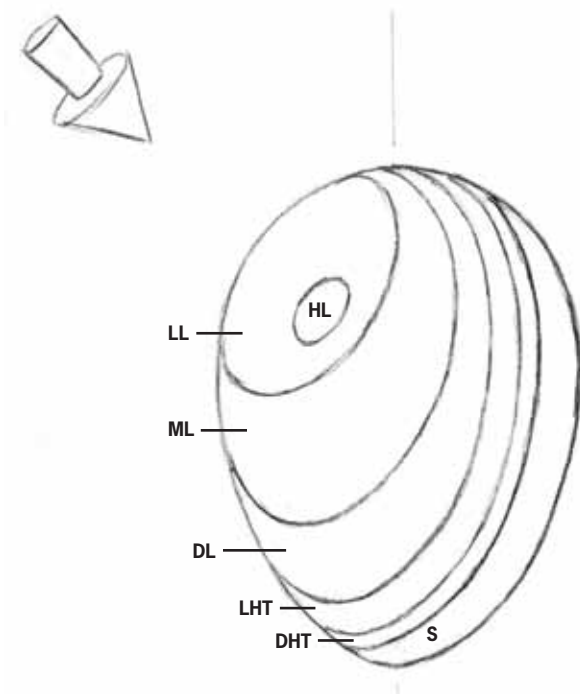

Illustration 9a



Illustration 9b

modeling factors. The modeling factors are the planes that represent themselves to the illumination at different angles. As a result, they produce different values. Each of these facets is a plane that has a name, and if an artist shades each plane with the correct value and in the correct sequence, the resulting shape will have three-dimensional form. If the gradations jump or skip, the illusion of form is lost. This takes practice—lots of practice—which is why it's best to start with a simple sphere before tackling more complicated objects.

In order from lightest to darkest, the modeling factors are the highlight, light light, middle light, dark light, light half-tone, dark half-tone, and shadow. The side view of the left sphere in Illustration 5 shows the relationship between the sphere's surfaces, the light source, and modeling factors. The right sphere shows the same modeling factors but from the point of view of the viewer.

Modeling Values on a Sphere

The surfaces that face the light (highlight, light light, and middle light) reflect the light. The surfaces that turn away from the light (dark light, light half-tone, and dark half-tone) deflect light, and as a result, they darken. (See Illustration 6.) In order to model form effectively, it must first be drawn by placing the shadow and the half-tones that surround it. The dark light, light half-tone, and dark half-tone—known collectively as the half-tones—are the most significant modeling factors to creating the illusion of round form in a drawing. Illustration 7a shows

a sphere modeled with just the half-tones and the shadow. As you can see, the illusion of form is quite apparent, even without the middle light, light light, and highlight.

Illustration 7b shows the sphere modeled with all the modeling factors. The inclusion of all the gradations results in a more realized illusion of form, and the highlight is now apparent. (In this example, the highlight is the white of the paper.) When modeling any form, the shadow is the first value to indicate. The less variation in value you draw in the shadow, the better start you'll have in modeling the rest of the forms.

The sphere resting on top of a cylinder in Illustration 8 allows us to explore the full range of modeling factors found in the shadows. Among the most important types of shadow for the draftsman are form shadows and cast shadows. Form shadows are found on the form itself and begin at the exact point where the incident light ends. A cast shadow appears when a form blocks out illumination and projects a shadow onto another surface—in this case a cast shadow appears near the top of the cylinder where the sphere has blocked the light. Cast shadows either show the shape of the form casting the shadow or reveal the shape of the surface that the shadow is cast upon. The cast shadow is normally darker than the form shadow. The reflected light shadow is the result of light reflecting from surrounding surfaces into both form and cast shadows. (It's generally more apparent in form shadows than in cast shadows.) The accent is the

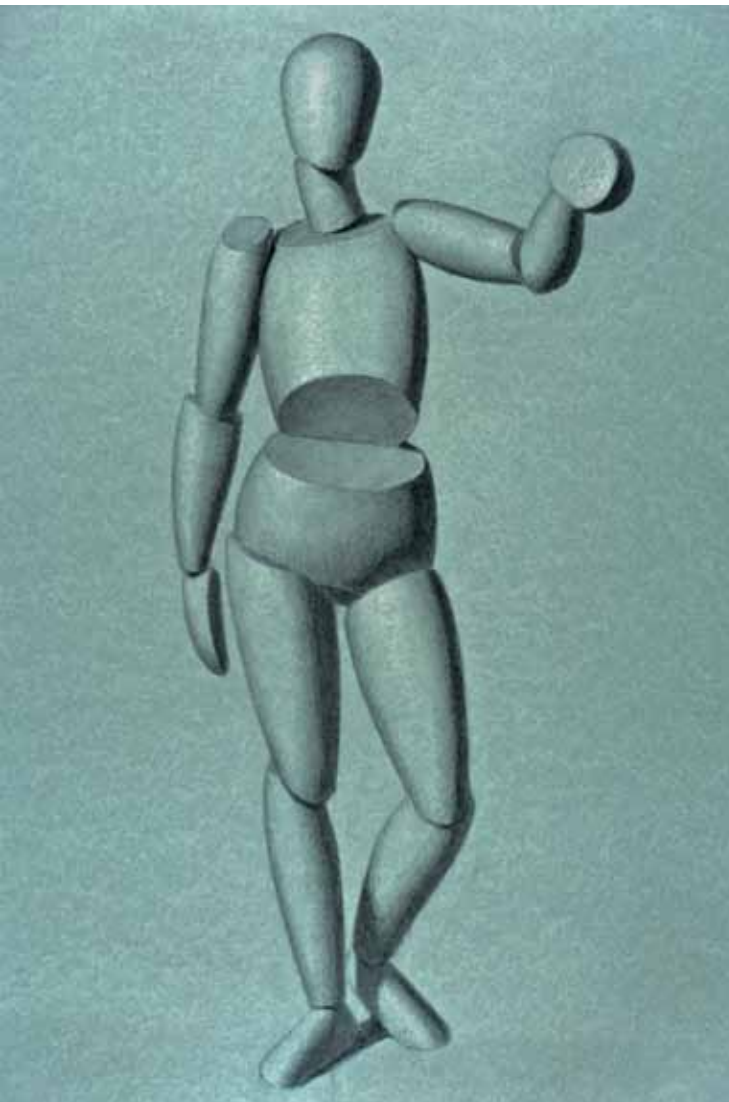

LEFT
Illustration 10a,
The Ovoid Girl (Front View)
by Jon deMartin, 2009, black and white chalk on toned paper, 24 x 18. Collection the artist.
After the sculpture *The Ovoid Girl* by Eliot Goldfinger.

BELOW
Illustration 10b,
The Ovoid Girl (Side View)
by Jon deMartin, 2009, black chalk on white paper, 24 x 18. Collection the artist.
After the sculpture *The Ovoid Girl* by Eliot Goldfinger.

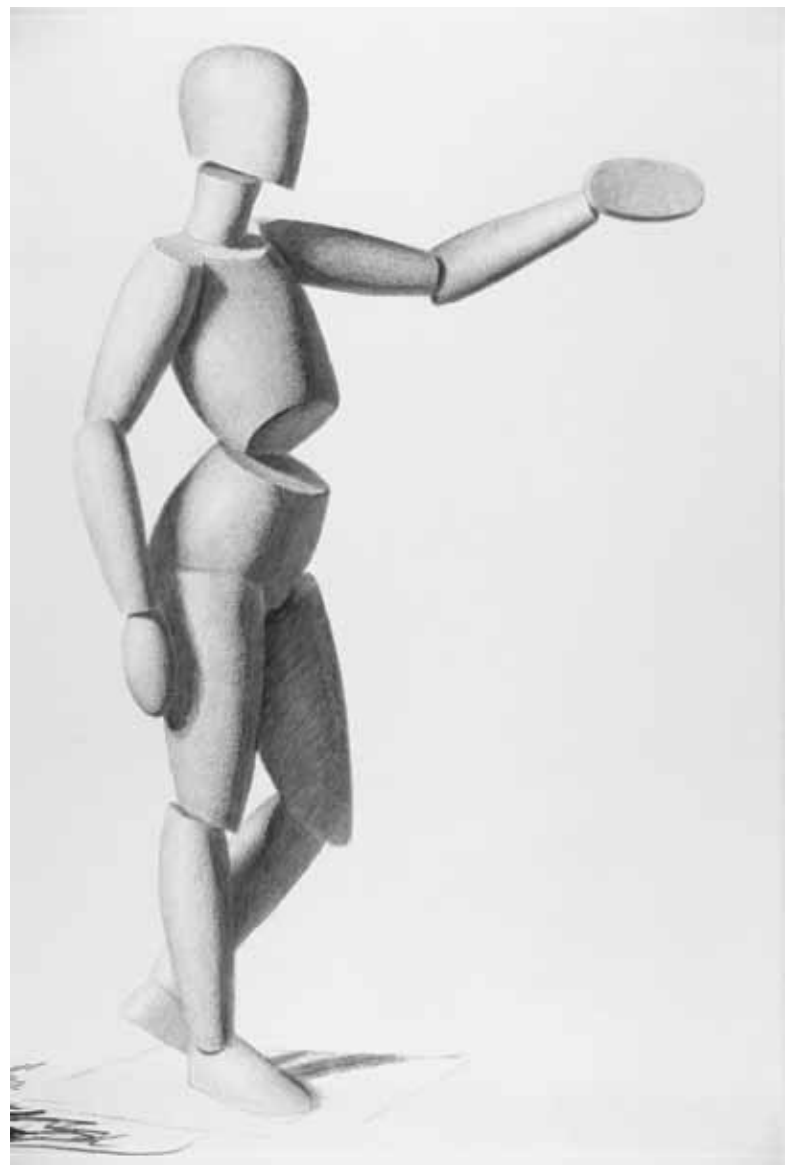

absence of light. It can be a deep hole or two forms touching one another, as seen on the rim of the cylinder touching the sphere. It is the darkest of all the darks, and it gives richness to a drawing.

Modeling Values on an Ovoid

The ovoid is a geometric solid that resembles an egg. It's similar to the sphere in that every part of the surface is curved, but unlike the sphere its curves are not equal everywhere, and the angle at which you hold an ovoid changes the shape that you see. It is longer in one direction than the other, and the larger end is rounder, and the smaller end is pointed.

The ovoid is an irregular form, so shadows and modeling factors behave differently than on a sphere. (See Illustrations 9a and 9b.) However, by knowing how light reacts to a sphere, the artist can take the same principles and apply them to the ovoid (or to any other form). The ovoid is also the first step in drawing a naturalistic object; it's a useful shape because of its relationship to the human form, being similar to the head, rib cage, and other parts of the body.

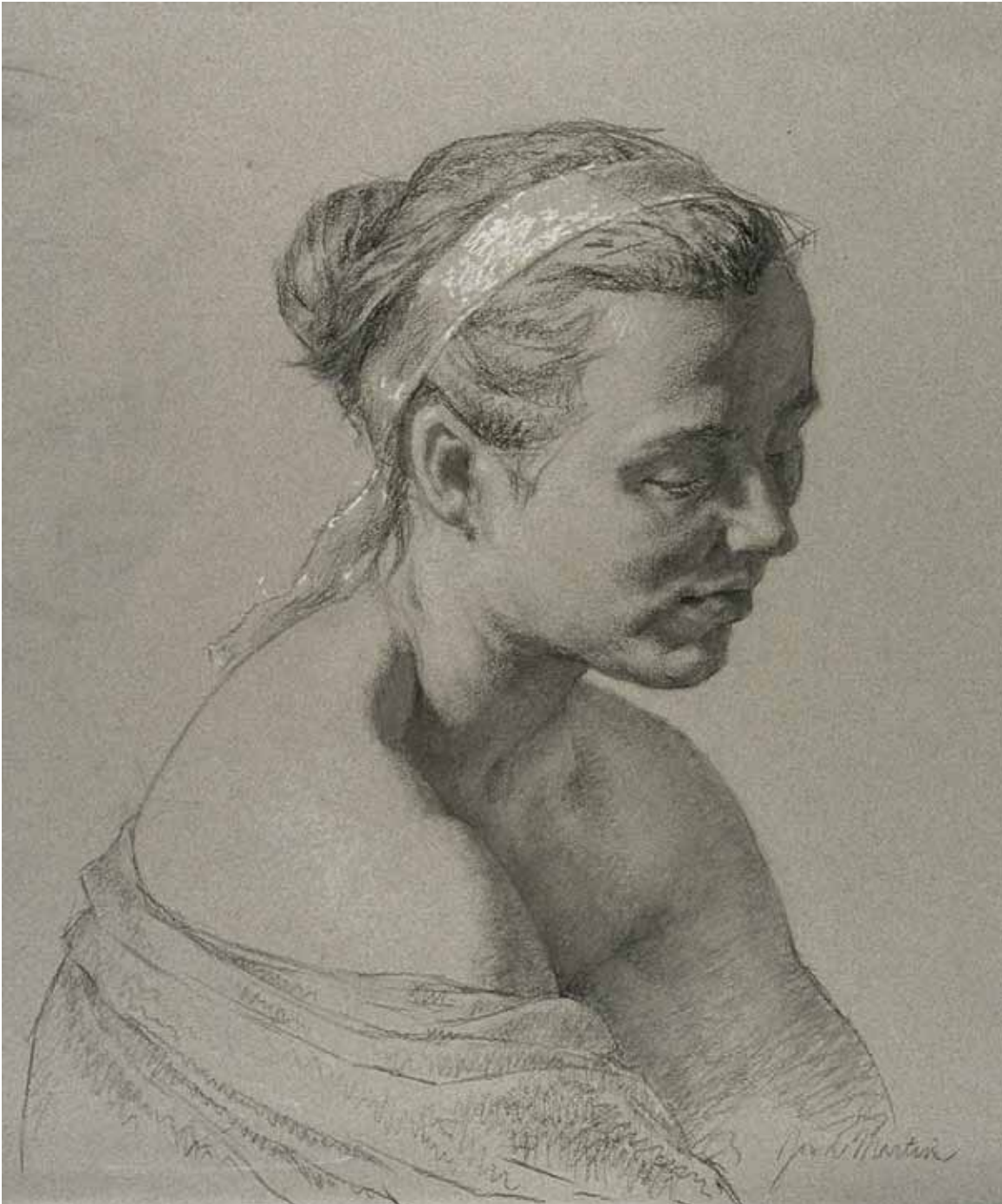

LEFT

Julie

by Jon deMartin, 2007,
black and white chalk on
toned paper, 20 x 18.
Collection the artist.

NEXT PAGE

Self-Portrait

by Jon deMartin, 2010,
black and white chalk on
toned paper, 17 x 14.
Collection the artist.

Illustrations 10a and 10b show front and side views of an ovoid figure, and these drawings show that the characteristics of double-curved surfaces apply to ovoids as well as to spheres. Every form has its brightest part. Whether wide, flat, deep, narrow, long, or short, each surface still turns in two different directions.

The brightest parts of an ovoid (or a sphere) show a more concentrated amount of light than the brightest part of a cylinder does, because the cylinder's surface only bends one way. The surface of a cylinder runs

straight along its axis, whereas the forms of *The Ovoid Girl* are convex and continually gradate.

The head is a perfect form to end this discussion with because it's a shape that closely resembles an ovoid. The head is a complex naturalistic subject, but reducing it to its most basic shapes makes the task of drawing it more manageable. Light falls on the head the same way as on an ovoid. It has a shadow, highlight, and all the modeling factors in between. ■

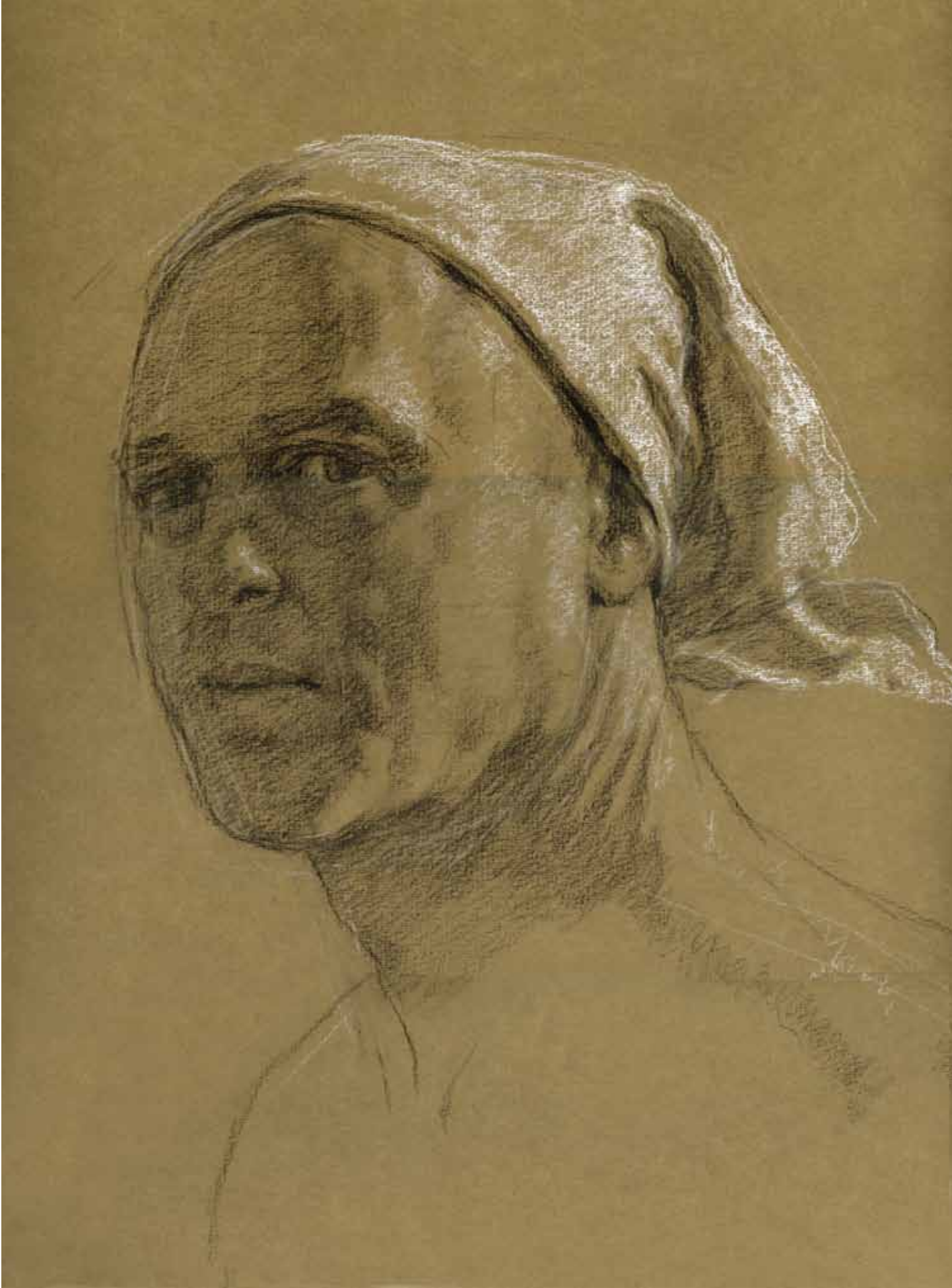



Modeling Complex Form

Learn to draw a value sphere by using a controlled graphite shading technique to render light shining on a three-dimensional object.

UNDERSTANDING HOW light falls on an object is fundamental to creating believable illusion. Drawing an imaginary sphere is a great exercise for learning how light and shadow behave on a simple object before you attempt more complex subjects. This lesson is also an opportunity to master pencil control and a light touch. Even if you draw and paint with a different style, developing refined pencil control and mastering a thorough understanding of light will help develop sensitivity in both your hand and eye, applicable to all subjects, styles, and media.

1. Block In the Contour

The first step is to **draw a circle**, following this easy method. Lightly sketch a square, and then slice off the corners to make a sketchy octagon.

Next, **indicate a direct light source** that's angled 45 degrees slightly toward the sphere by drawing a three-dimensional conical arrow from the upper left. Think of this as a wall of white light angled as though it's shining from a high, north-lit window.

Note: Use a 2H pencil to draw light, soft lines that you can erase easily—without damaging the paper! I like to draw three to four very light lines per stroke so the graphite is dark enough that I can see my lines. Unless otherwise indicated, use a 2H pencil for this exercise.

Draw the terminator. The direct light hits the half of the sphere closer to the light source, but the light can't reach the half turned away from the light source because light rays don't bend. The distinct, conceptual line between the two halves marks the ending of the light, so we call the line the *terminator* and draw it perpendicular to the light source. Later we'll make this line blurry and soft, but for now it's one distinct line.



Sketch the cast shadow. The limits of the cast shadow are determined by lines, parallel to the light source, which are also tangent to the circle at both visible ends of the terminator and extend down to the right to define the edges of the shadow “cast” on the ground. Envision these lines and sketch in a horizontal ellipse for the cast shadow within these limits.

2. Refine the Contour

Smooth out the circle contour, continuing to slice off corners of the evolving polygon shape in progressive steps—carefully and methodically proceeding until a smooth circular form emerges. This is a slow, gradual process, so be patient. If your circle gets flat or lopsided, think of filling it up with air and pushing out the “dents” from the inside. Your lines should all still be soft, light, and easy to erase. Use a pen-style retractable eraser (see Materials, page 20) to clean up the lines so they're very thin.

Pencil in the two “poles” of the terminator and sketch an ellipse to represent the terminator between these two poles. Erase the back half of the ellipse so the terminator appears to be half an ellipse on the visible side of the sphere.

The terminator is an ellipse because the light source is three-dimensional and angled slightly from the front. If the light source were directly from the side, the terminator would be a flat line. Many portrait paintings show a light source angled from the left upper corner and tilted slightly from the front because that angle reveals a more sculptural form.

3. Fill in the Shadows

Using the softer H pencil, **fill in the form shadow** (the shadow side of the sphere) **and the cast shadow** with one even, medium tone. Make short strokes with a very light touch, and angle your marks in a variety of directions. If all your shading strokes go in the same direction,

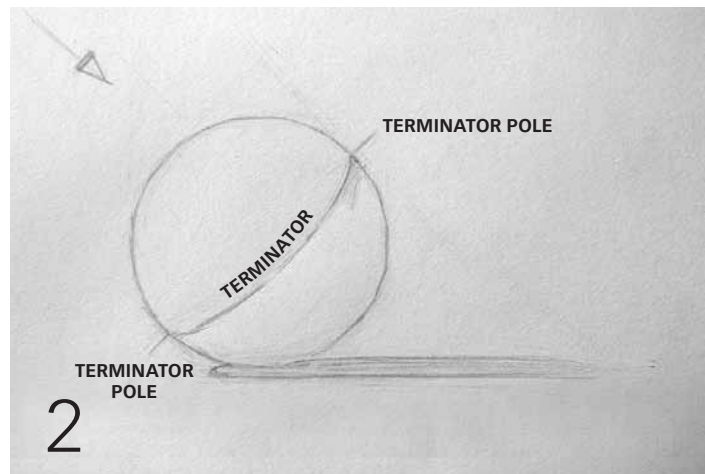
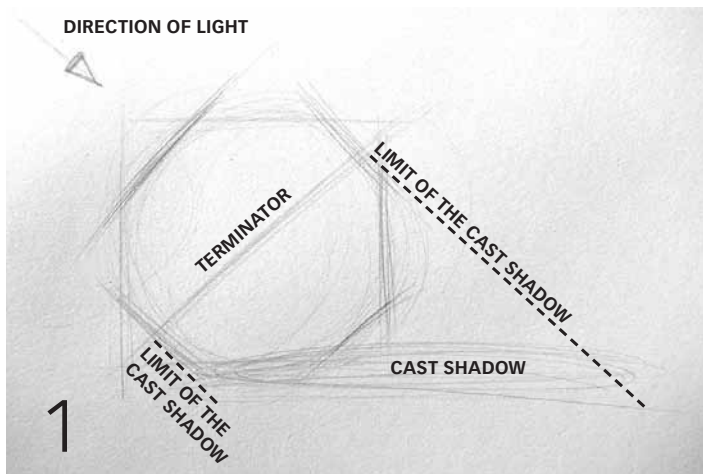

your sphere will look “hairy,” so change directions often. At this point your sphere should look flat and graphical.

Don't press hard on the pencil as you fill in the shadow areas; just hover your pencil softly in one area to build up a medium value without damaging the paper. You might notice tiny dots of

darker graphite building up on the paper. You can use your kneaded putty eraser, twisted into a sharp point, to “tap out” the black dots and texture.

4. Turn the Form

Use shading to make the sphere appear round. Making an object look three-dimensional is called *turning the form*. Starting at the terminator, with a 2H pencil, shade a mist of light marks up toward the highlight, the area where the light on the object is brightest. Keep darkening the values nearest the terminator until its sharp edge begins to soften and the form starts to look round.

Think about the surface three-dimensionally as you work: imagine you're a small ant walking over the surface as it turns up towards the light. The more you think sculpturally, the deeper will be your understanding of the form, and that knowledge will improve your drawing.

Don't blend! One goal of this exercise is to develop a light touch and an even shading technique—without relying on blending. If you rub the graphite, it will look greasy and sometimes the pigment will shift toward an unpleasant brown hue.

5. Refine Shading

Finesse your modeling on the sphere.

Layer H and 2H pencil shadings one over the other. An H (softer) pencil will make a darker value, but you will also see more grain and texture. Using the 2H pencil over the H pencil shading will even out the texture by filling in all the little white speckles that are left by the deeper crevices of the paper.

Refine the cast shadow. The place where the sphere sits on the ground and touches the cast shadow should be very dark since no direct light can reach there. Allow the edges of the sphere and the cast shadow to merge at that spot.

Develop the reflected light as you refine the shading. So far we've only discussed the direct light source and the shadow. Reflected light is caused by ambient light in the room or light bouncing off the ground and onto the shadow side of the sphere. Don't erase to create reflected light or the area will be too light and will ruin the sense of three-dimensional form. Instead, continue to darken the area just behind the terminator, and the reflected light will naturally emerge.

Keep the area of reflected light subtle; you may find you even need to darken it. If it's the correct value, it should disappear completely when you squint hard at your drawing.

Pencil Grades

Graphite pencils are graded by hardness: harder pencils (H, 2H, 3H, 5H, etc.) make lighter, finer marks, and soft pencils (HB, B, 2B, 4B, 6B) make darker, broader marks. (Some brands have an “F” grade between the hard and soft pencils.)

I encourage you to begin with just two pencils (H and 2H) to learn how to get the widest possible range of value just by way of controlling the pencil. After you master this, you can try a wider range of hard and soft pencils.

Materials

Paper: **Strathmore** 400 Series drawing paper pad, medium surface, 14x17 (Please be careful to buy the exact paper pad listed; look carefully for the “400.” Don't buy “sketch” or “recycled” paper; they're both much lower quality and will create problems. The correct pad has a brown cover, spiral binding along its short edge; and it shows a drawing of a woman's face.)

Pencils: **Staedtler** Mars Lumograph 100 (blue wood) 2H and H—at least five of each

Erasers: kneaded rubber eraser;

PaperMate Tuff Stuff retractable eraser stick (This small white eraser has a black plastic pen-style case and is found with the drafting supplies; other brands are too wide.)

Drawing board: **Helix** lightweight, metal-edge, 16x21

Other: sandpaper—220-grit placed flat on a table or mounted on a block or handheld detail sander; **X-Acto** snap-off blade cutter (small utility knife—retractable snap-off style—not a large blade box-cutter and not a scalpel knife); white “artist's tape” (low-stick masking tape called “artist's tape,” found in art supply stores)

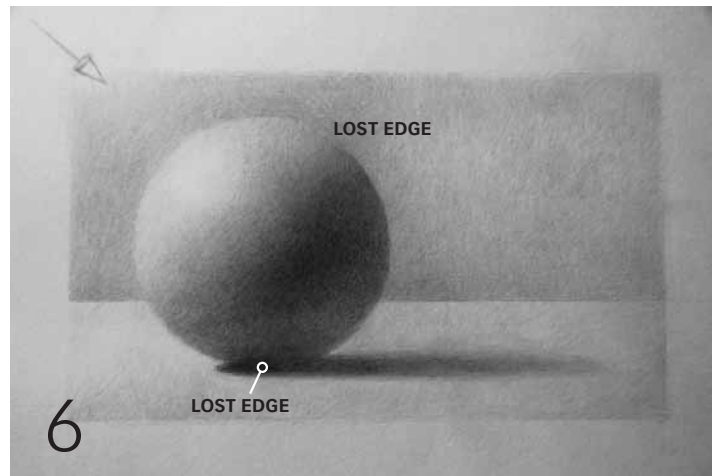
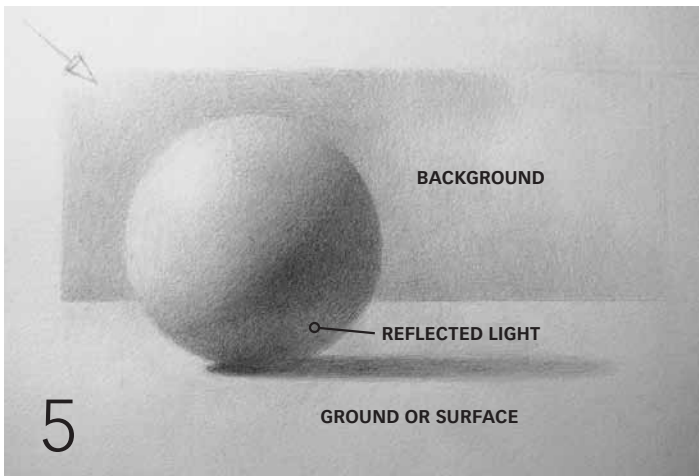
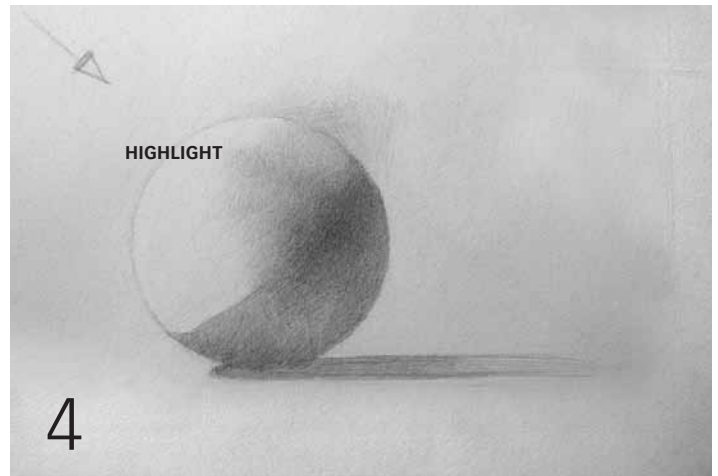
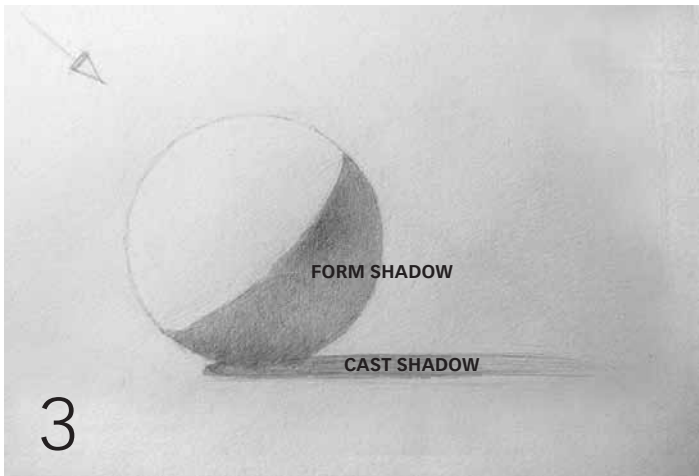

6. Do the Final Shading

Shade in the background and surface. If your goal is a completed drawing, filling in an even tone for the background and a lighter tone for the ground the sphere rests on will result in a nice, finished look. Be careful, though, that you don't create a

dark little cloud “hugging” your sphere. It can be tempting to make the background dark right around the edge of the sphere, but that will cause the background to jump forward. To make the background sit back visually, keep it one even tone and fill in the rectangle of the picture edge.

Refine all values, continuing to adjust them across the entire drawing, layering H and 2H pencils as necessary. In some places the background will be the same value as the sphere. Allow these edges to disappear; these lost edges create a feeling of atmosphere and depth.

When your drawing is successful, your sphere will look as though it could roll right off the page, or as though you could pick it up. That's when you know you've captured the illusion of three-dimensional form.

Once you've mastered the value sphere, you can use this shading technique to draw any subject. You will be thinking sculpturally, and the successful

Learn More ONLINE

See larger images of Valeri's demonstration, plus download her free value sphere worksheet in PDF format, at www.artistsnetwork.com/learnmore2013.

illusion of solid, three-dimensional form, along with your refined pencil technique, will strengthen all your drawings. ■

SADIE VALERI, who has taught graduate students at the Academy of Art University in San Francisco, currently conducts workshops and classes at Sadie Valeri Atelier in San Francisco. Known for her meticulously crafted still life oil paintings, she was judge for the still life category of *The Artist's Magazine's* 2012 Annual Art Competition and has created a video demonstration of how to draw the value sphere, available to download. To watch a preview and purchase the video, go to www.sadievaleri.com/videos. Visit her website at www.sadievaleri.com.

Sharpening Pencils

A very sharp pencil gets its point down into the texture of the paper, which creates a smoother tone, even when you use a light touch. Sharpen your pencil first by whittling away the wood with an X-Acto snap-off blade cutter (the large box cutters and scalpels don't work as well). Expose an inch of graphite lead, then rub the side of the graphite on sandpaper, turning the pencil constantly, to create a very sharp point.

USING VALUE TO CREATE FORM

You create form in a drawing by using value to depict light and shadow. Develop value variations carefully and slowly, and only after carefully observing the tones on the subject itself. Be sure to consider the character of your subject. For example, round or soft, turning forms will have a soft, gradual value change, while sharper edges will have a crisp, abrupt value change.

It is also vital to consider the location of

your light source when using value variations to model forms and create shadows. Be sure that your highlights and shadows are located consistent with the direction of the light. Also consider the differences between types of shadows. *Form shadows* are those dark areas on the side of an object where the light does not hit; *cast shadows* are those dark areas where the light has been blocked by another object.

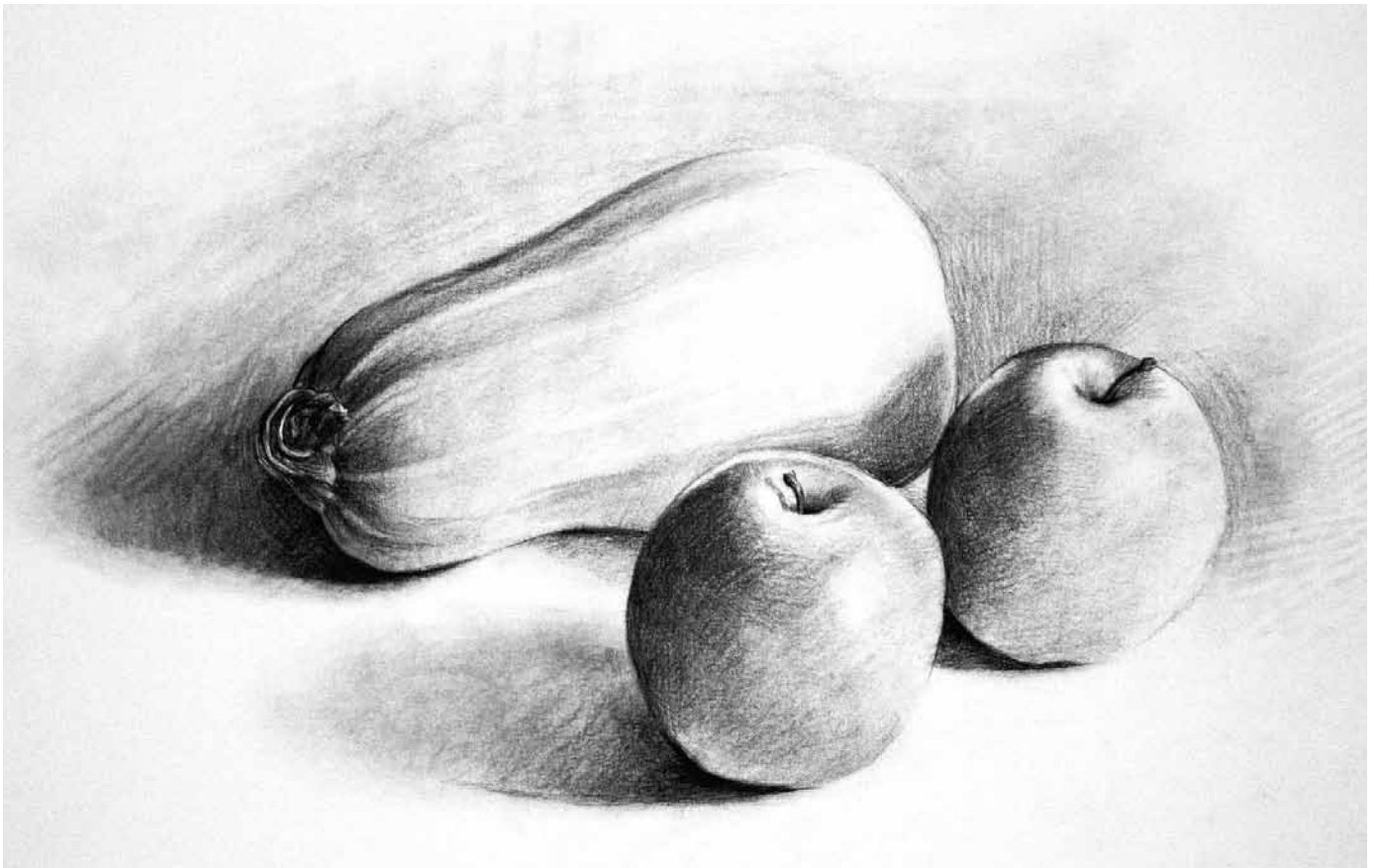

Light and Shadow Are Necessary to Create Form

The three relatively simple forms here (a squash and two apples) are all light in value. This enables shadow tones to show well. A single light source helps define the forms.

THREE PART COMPOSITION

Charcoal on bristol board
12" × 18" (30cm × 46cm)

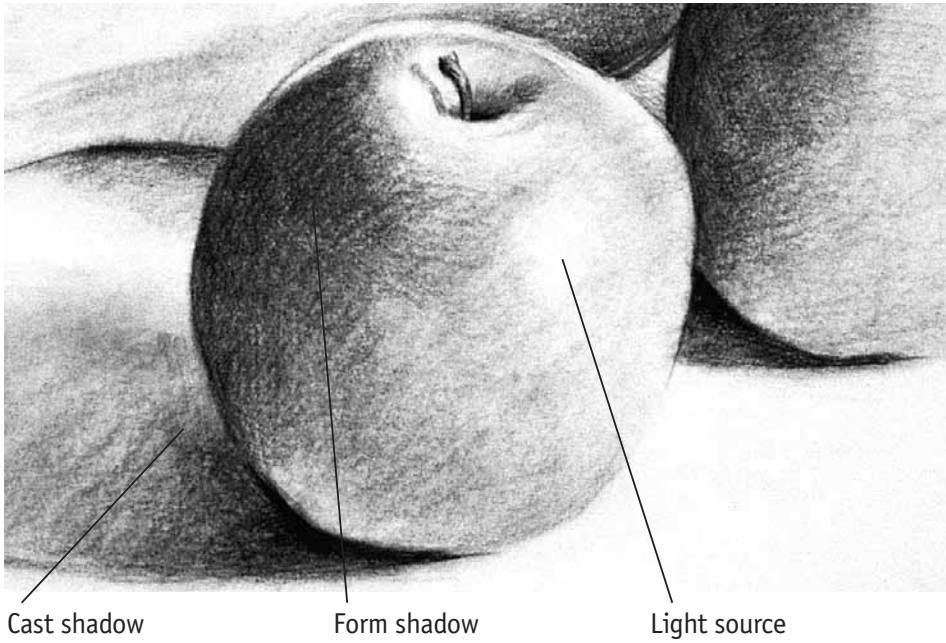

Detail of Apple

The form shadows in the apple goes from light to dark as the light source gets further away. A similar principle applies to the cast shadows, only they get lighter the further they get from the object.

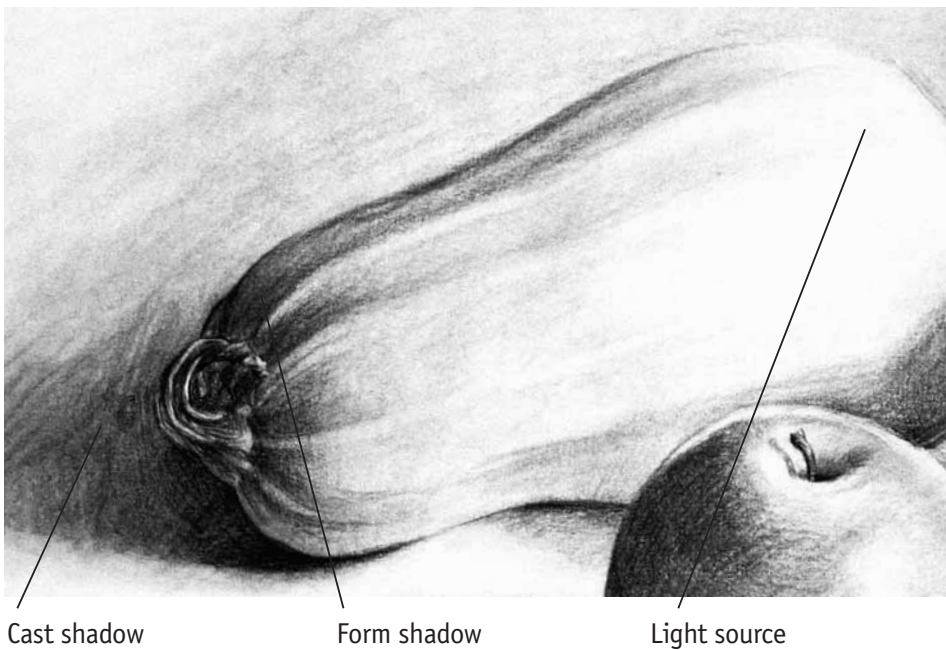

Detail of Squash

For the squash, I use form shadows to create the effect of the ridges. Notice how the top of the ridges are lighter (where the light hits) while the bottom part of the ridge is darker. I also gradually darken the values to give more shape to the ridges.

USE A SINGLE LIGHT SOURCE

To make value changes on your subject easier to see, shine one light directly on your subject and block out other unnecessary light.

UNDERSTANDING LIGHT AND SHADOW

Our eyes depend on light and shadow to define form, so it is important to understand the basic properties of light and shadow to create form in drawing.

Most objects you portray with tone and value will exhibit the following:

- *Form light*. The area facing and struck by the light. This producing the lightest part, or *highlight*, of the object.
- *Form shadow*. The area where light does not hit.
- *Hard edge*. A characteristic of forms with crisp, well-defined edges.
- *Soft edge*. A characteristic of rounded forms where edges are not clearly defined.
- *Cast shadow*. The shadow created on a surface when the light on the surface is blocked by another object. It is usually hard-edged.
- *Reflected light*. Lighter areas within a form shadow, created when a bit of light is reflected back onto it.
- *Core shadow*. The darkest part of a form shadow, not affected by reflected light.

Different Aspects of Light and Shadow

These three simple white forms show the various aspects of light and shadow modeling. White objects work best for this because there is no local color variation to interfere.

WHITE FORMS

Charcoal on heavy bond paper
10" × 16"
(25cm × 41cm)

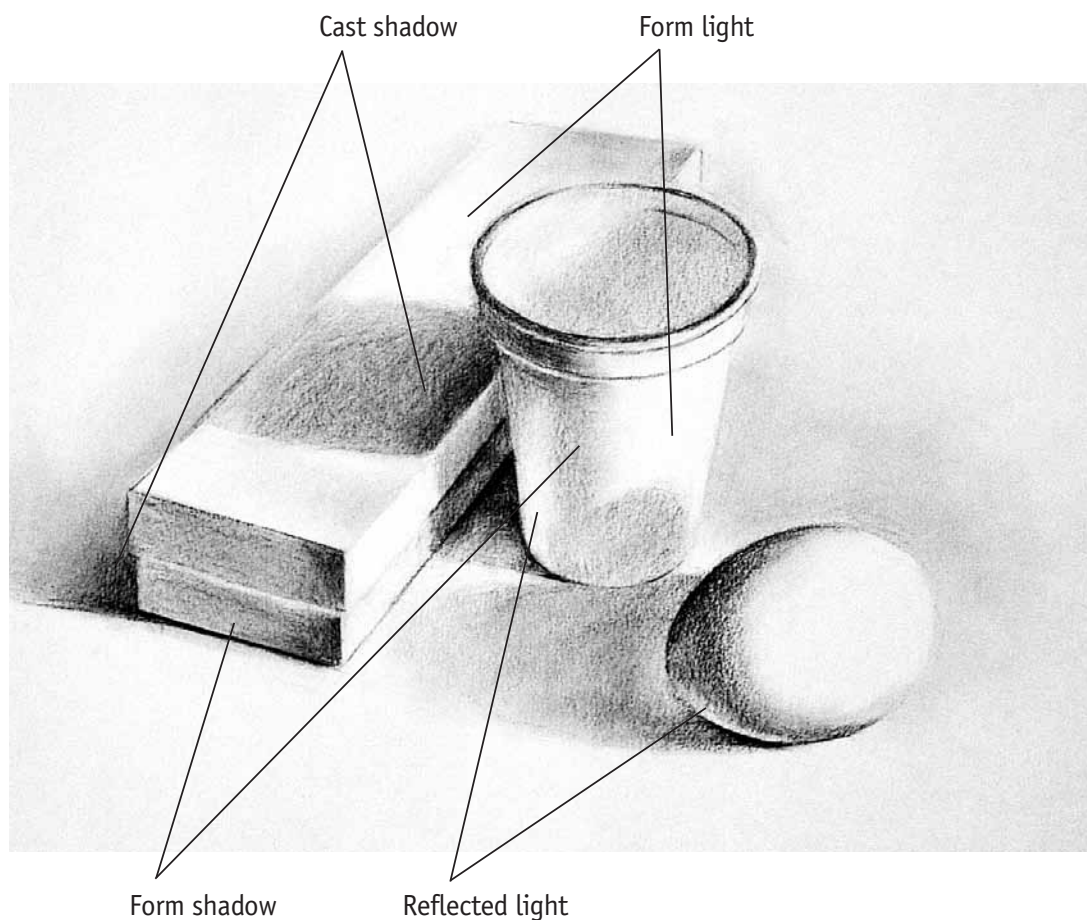



Fine, sweeping lines
create the texture of hair

Strongly directional lines
indicate the contours of
the animal

Use Charcoal for Texture

In this sketch, I used soft charcoal to create different textures for this ram. Although the charcoal was soft, I did this entire sketch without blending. Instead, lines create the shading and give the animal form. Tone and line are more concentrated in the head area for focus.

THE BACHELOR

4B and 6B charcoal on gray
sketching paper
24" × 18"
(61cm × 46cm)

Using Values to Create Light and Shadow

Here you'll learn how to map out the patterns of light and shadow as well as develop the principles of light and shadow. Since your paper is toned, let it act as the middle value for this drawing, applying lights and darks on it.



1 Sketch in the Subject

Study your subject. Then, using a 4B charcoal pencil, lightly sketch on the smooth side of the paper. Do not worry about light and shadow yet.

Materials

SURFACE

18" × 24" (46cm × 61cm) light gray Canson paper

MEDIUMS

4B and 6B charcoal pencil
Soft vine charcoal pencil
White charcoal pencil
Soft white pastel

OTHER MATERIALS

Facial tissue



2 Map Out the Value Variations

See the basic patterns of lights and darks by squinting your eyes as you look at your subject. Using the side of a 6B charcoal pencil, lay in the areas where you see the darks. Pay special attention to darker value patterns such as cast shadows (page 84).



3 Build Darker Values and Add Shadows

Switch to a piece of soft vine charcoal and use it to strengthen the dark values. Use a piece of facial tissue to lightly rub the vine charcoal, blending the tones, solidifying the shadows and unifying the darks. Don't worry if you smear some of the charcoal into the light areas. Shape your kneaded eraser into a point and use it to clean up any areas where you don't want darks. Spray a light mist of workable fixative over the drawing. Allow it to dry.



4 Strengthen the Value Contrast

Add soft whites with a white charcoal pencil. This will strengthen the value contrast in the flesh tones, the skirt, a bit of the hair and the reflections in the wall on the right.

5 Amplify the Value Contrasts and Finish

Re-examine your subject, looking for the darkest darks within the shadows. Use the 6B charcoal pencil to clarify and refine values and edges of the shadows. Follow this same procedure for the lights. Use a white Nupastel for the lightest lights. With the 6B charcoal pencil, add the pattern detail in the dress and, with a soft white pastel, amplify the value contrasts where necessary.

A SEAT IN SOHO

Charcoal and pastel on gray Canson
18" x 24" (46cm x 61cm)

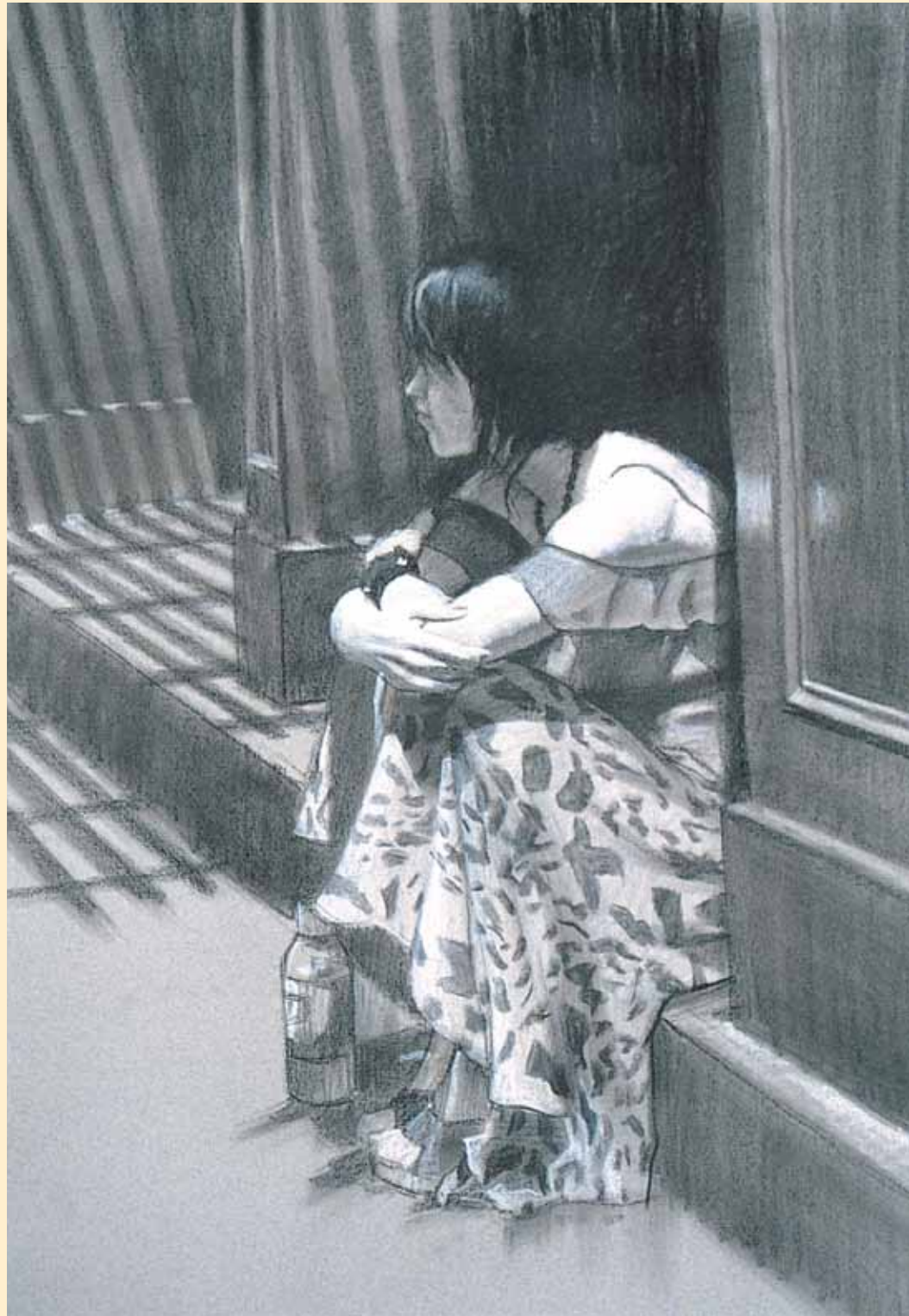

LOST AND FOUND EDGES

In order to add a dramatic effect to a drawing, use the concept of . A lost edge occurs where the edge of the form seems to disappear into the background. You lose light edges in a light space or dark edges in a dark area. Basically, a lost edge fades into an area with a similar value, while a found edge relies upon contrasting values to define it.

One strong light source and a dark background will provide ample opportunities for dramatic effects. Keep your use of contour line to a minimum. Use it only in discrete places as a very subtle accent. Most of the form should be defined by the edges created by the transitions between light to shadow. Add some limited details and softer descriptive values within the light side of the form.

CHIAROSCURO

The lost-and-found idea is not new. Caravaggio, a Renaissance painter, used this concept to give a sense of drama to his work. *Chiaroscuro*, meaning light and shadow, is the term associated with such dramatic, highly contrasting tonal effects. In this approach, the darks basically melt into the background, allowing the subject to emerge out of a dark void.



Use Lost and Found Edges to Create a Dramatic Effect

The contrast of strong black and white creates drama as this figure almost emerges from the deep shadows of the background. I used midtones and lights to clarify the details.

WHITE ON THE ROCKS

Charcoal on artists' vellum
24" × 18" (61cm × 46cm)

Using Lost and Found Edges

Lost and found edges can make your subject look like it's in motion, which is perfect if your subject is a dancer in mid-leap. The focus will be the upper body, so that will have the most detail, while the legs will remain blurry to suggest action.



1 Lightly Sketch the Subject

Draw a light gesture sketch with a 6B charcoal pencil. Be sure to maintain proportional accuracy.

Materials

SURFACE

20" × 18" (51cm × 46cm) artists' vellum

MEDIUMS

6B charcoal pencil

Black soft pastel

OTHER MATERIALS

Kneaded eraser

Paper towel or facial tissue

Workable spray fixative

DRAW LIKE A PAINTER

When you draw on white paper, let the white of the paper be your lightest light. Shape your kneaded eraser into a point and use it to lift out the highlights, just as a painter uses a brush to lift paint.



2 Lightly Add the Initial Layer of Shadows

Use the 6B charcoal pencil to lay in the overall shadow tones on your subject, but keep them lighter than they appear. (You will build the darks later.) Lay in the background in the same manner.



3 Soften the Edges and Clean Up the Light Areas

Use a soft paper towel or facial tissue to smear these initial tones. Do not be too concerned about smearing the tones into the white areas or over edges. You may use a kneaded eraser to clean up some light areas. Leave soft edges in the legs to suggest movement.



4 Add Another Layer of Darks and Refine the Lighter Tones

With a soft black pastel, add another layer of darks and repeat smearing to deepen the darks, losing edges in the background. Shape a kneaded eraser to a point and use it to carefully lift out the lighter tones and bright, clean lights in the upper body. Add a light layer of workable spray fixative and let this dry for 2–3 minutes.

VARY THE PRESSURE AS YOU LIFT HIGHLIGHTS

Use lots of pressure to lift out a nearly white highlight. Use a little pressure when a soft gray is what you need.

5 Add the Final Details

Use a very sharp (page 73) 6B charcoal pencil to carefully add another layer of darks. Keep the shadow edges lost. With a kneaded eraser, delicately pick out the lights. Add any subtle line work that may be needed to refine some areas. Keep the legs and feet more blurred to suggest action.

DANCER'S LEAP

Charcoal and black pastel on artists' vellum
20" × 18" (51cm × 46cm)

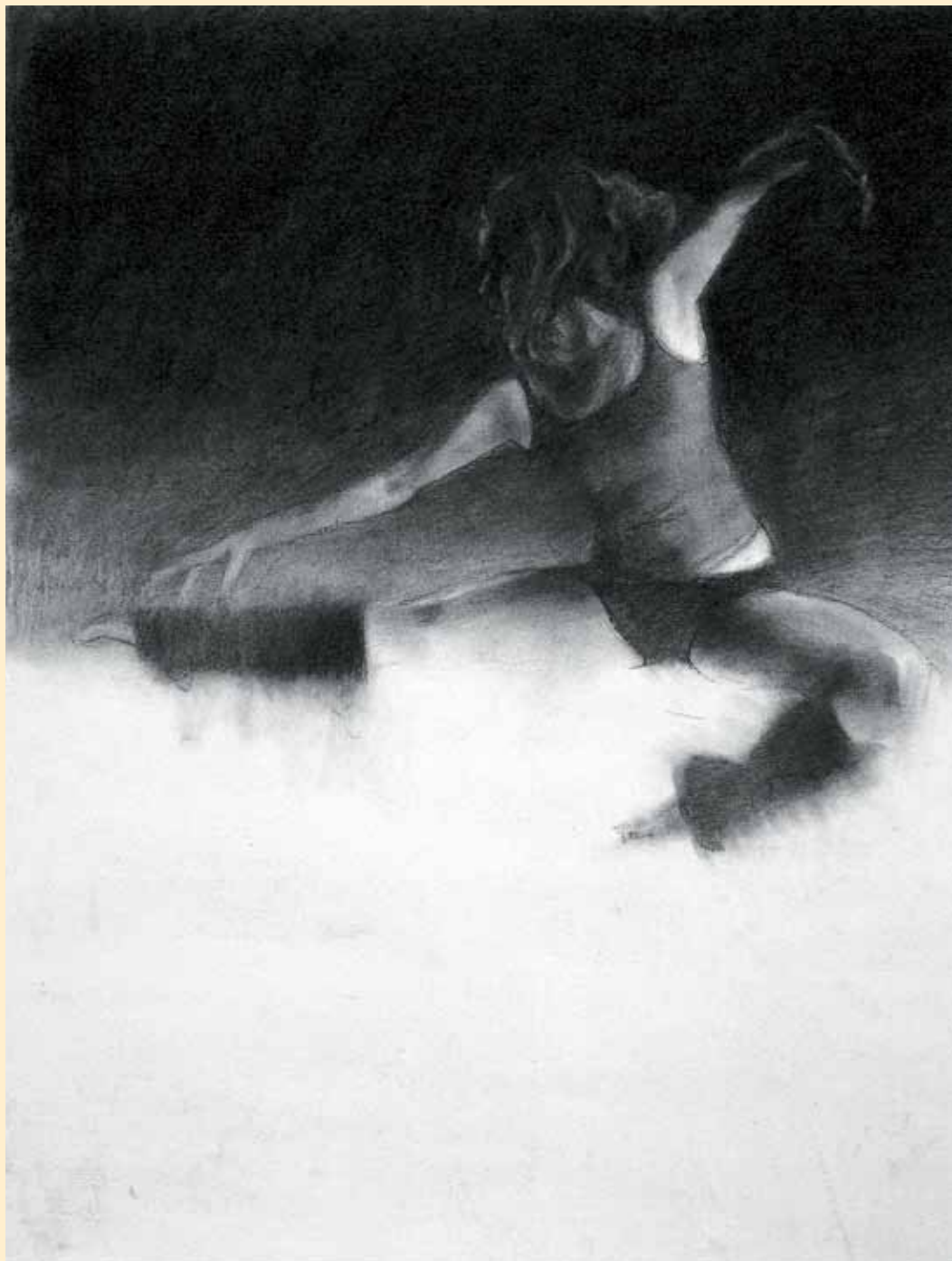

DEMONSTRATION

Capturing an Edge With Contour Line

There are two ways to define the edge of any form: with value changes or with line. Whenever you create a drawing that utilizes both line and value, you will have to decide which will be dominant. I am primarily a value artist, but I love the beautiful line work of such masters as Rico Lebrun and Hokusai. I utilize contour drawing in two instances: I use it to define some of the edges where figure and ground are the same value and when I don't have time for a complete value drawing of a scene—in which case, I do a contour line drawing of all the shapes involved and fill in the values later. The most difficult part is knowing when to stop. I could use someone to snatch my pencil away.



Reference Photo

I like the way shapes of shadow define Alma Larson's face and hand.



The edge of the light shape here defines the structure of his cheek. It's not arbitrary.

Each turn of the shape's edge reveals a different aspect of the form—a depression, a protruding chin, etc.

The overalls are defined by unique shadow shapes.

Each finger has a different shape of light defining it.

Define the Shapes

After the initial search for relationships, my first use of contour line is to define (lightly) the shapes that will be left as white paper. Instead of drawing eyes, nose, mouth and fingers, draw the shapes of light value. If you have trouble seeing them, squint until you see only the shapes of value. Draw those shapes slowly with a deliberate line. Be careful to note each turn and undulation in the edge.

Merge the dark figure and the dark background in a single value. If you define this edge, you rob the viewer of figuring it out.

Put in the gray, leave the light shapes.

Define the light edge of the hat with some dark in the background.

Lose the edge of the hat here as it merges with the light.

Carve out the lights by placing darks next to them.



2 Lay in the Values and Define the Edges

The idea here is to have the figure emerge from the dark shadows behind him. Put in the value and let the light shapes pop out. Apply powdered graphite using a piece of thick piano felt as a brush. Lay in the background dark and carry it across and into the figure. It does not have to be recognizable, just dark. Don't let the photo tell you what to do. Define the intricate edges with a blending stump. Lift out small pieces of light such as the edge of the hat brim and the brass button with a kneaded eraser. Some edges will be lost.

These lines along the shoulder were pulled with a 6B pencil.

The pencil can be alternately dragged sideways to produce broad lines, then lifted for more delicate lines.

One careful line can give all the necessary information about the zipper flap.

Start near the center of interest—his face. Define a few contours with deliberate, carefully pulled lines.



3 Select Areas to be Defined

Too much contour line would ruin this drawing. To keep the dominance on value contrasts, carefully select the areas to be defined by line. Resist the temptation to define everything. Leave in lost edges, choosing the contours that best describe the form.

ALMA LARSON

Powdered graphite and graphite pencil
16" x 12" (41cm x 30cm)

Finding value relationships

Three things affect the value of any surface:

1. The local tone, or the actual value of the surface free from the effects of light and shadow.
2. The brightness of the light source. Even a dark local tone can have a highlight from a strong light source.
3. The direction of the light source. Surfaces at right angles to the light source receive the most. As a plane turns away, it receives less light and becomes darker.



Everything Is Relative

Values are only evident in relation to other values—a light object will appear lighter next to something dark and vice versa.

The Different Areas of Value

A black and white sphere is a good illustration of the six different areas of values that form under a light source.

Capturing These Relationships

There are numerous ways to render the changes of value you see. The method you choose is completely personal, a result of your likes and dislikes and your choice of medium.

Don't worry about developing a personal style. Learn to see value relationships, become familiar with the various media, and your personality will imprint itself on your drawings naturally. Later, I'll teach you how to render these relationships using the most common drawing tool, the graphite pencil, so you can focus your attention on seeing the relative value in the subject.

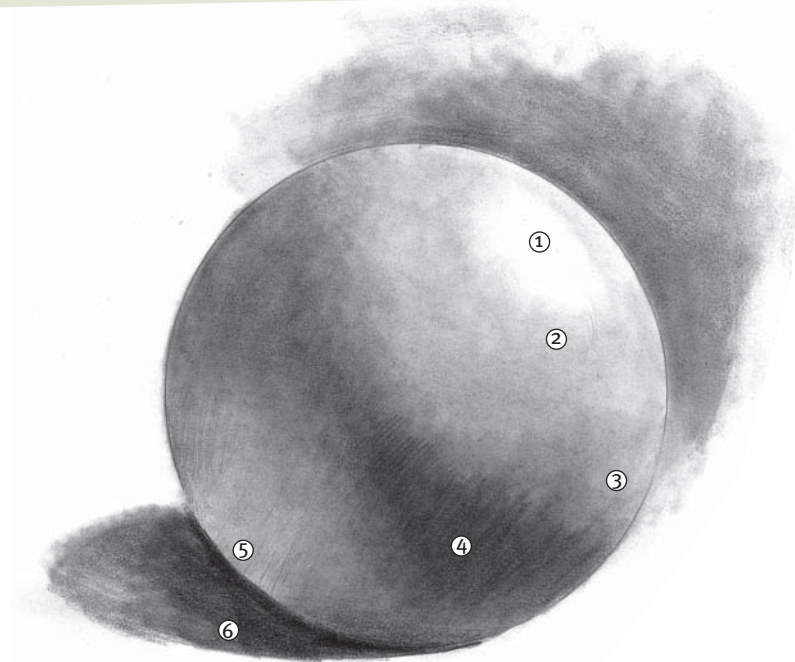

1 Highlight: The area receiving the most direct light.

2 Light: The surface area receiving indirect light.

3 Shadow: Where the form turns gradually away from the light source.

4 Core shadow: The most concentrated area of dark on the sphere. Since it is parallel to the light source (which is coming from above right), it receives the least amount of light.

5 Reflected light: Light bounced back from nearby surfaces. Reflected light is still part of the shadowed area and as such is never lighter than the shadow area on the lighted side of the sphere.

6 Cast shadow: The shadow cast by the object is almost always darker than the core shadow. The length of the cast shadow depends on the position of the light source. It's darkest and its edges are sharpest nearest the object.

Making a value scale

It is impossible to create with any medium the full range of value shifts that you can see in nature. Simplifying the range is a necessity. Most artists use the standard value scale, which divides the ranges of value into nine increments: a middle gray, four gradations of darks and four of lights. This may not seem like a lot, but it's actually about as many as most people can easily distinguish.

Creating your own value scale is a useful exercise for learning to adjust a value to the values around it. Divide a 9-inch (23cm) rectangle into 1-inch (3cm) segments. Using a 2H pencil and very little pressure, shade the first segment a very light gray. Switch to a 6B pencil and make the last one as black as you can get

it. Now shade each of the remaining segments in even jumps between these two extremes. You may want to use a blending stump to even out the value in each segment.

Two problems will arise: First, the transition from one segment to the next may vary—you might have a minor jump in one place and a huge jump in another. If you adjust one, you have to adjust all the rest. Note: it is easier to make a value darker than lighter.

Second, the value in one segment may become lighter as it approaches the border of the next. This will cause you to shade the next segment incorrectly because you're basing it on the border value and not the interior. As always, it's helpful to step back and squint.



The Value Scale



Practice With Your Scale

Gather a few simple items that are light in value. Hold up your value scale and find the square that most closely matches the value of an area. Comparison is one of the most important abilities needed.



Practice With Your Pencil

Here is a great subject for drawing value relationships and the effect of light on a curved surface. Squint and use your scale to capture the values correctly.

Rendering Shapes of Value

All forms, from people to trees, are made of shapes of varying value. Some of these shapes are very distinct and some have blurred edges. Accurate drawing requires seeing and recording the configuration of each value shape, their relative values, and the edges where these shapes meet. This gull is made up of light, gray and dark shapes. Forget about the bird and focus on the value.



Reference Photo

Your intellect sees birds in terms of legs, feathers, eyes and beaks, not shapes of value. Take your focus off these nameable items and put it on shapes.

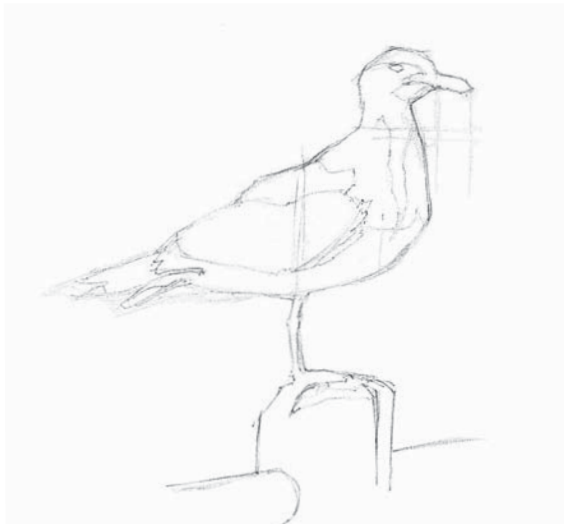

1 Begin with a Search for Angles

Begin with the angle of the shapes, the relative size of each shape and the relative position of key points. After that, you're ready to conduct a search for relative values.



2 Establish a Range of Values

There is no right place to start adding value to a drawing, but if you're comparing values (and you should), establish a standard to compare them against. I look for one of the extremes of white or black and begin there. Compare the lighter range of values to the white of your paper. This subject has a black shape. Perfect!

When you squint, you see that there are two tones in the dark shape: black and a dark gray as the rounded plane of its back turns toward the sky. Put this black in with a 6B pencil. Now you have a standard of comparison for the gray tones.

This is the darkest value on the bird. Notice how it gets lighter as it moves up the back.

These two areas are the same value.

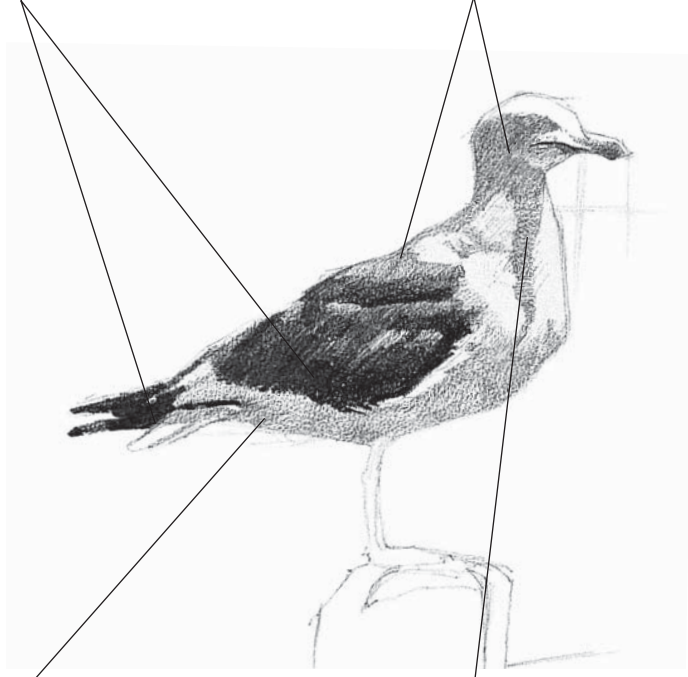

The shadow area on these white feathers is the same as the shadow on its neck.

This shadow is the only information about the undulations in the chest and neck. Change it and you change the bird.

3 Establish the Middle Grays

This is where squinting is crucial. Your intellect tells you that the bird is black and white. Beginning students typically accept that information and hesitate to violate the white very much. Consequently, the shadow area is rendered far too light. Squint and compare the value on the back of its neck with the dark gray of the light-struck back. A highlight on the black shape is the same value as the shadow on the white shape!

Every dip and turn in the shape of the gray is important: Each turn, each change in the edge tells you where the form turns in space, where it dips or bulges.

4 Finish with a Refinement of Shapes

When we put in the dark of the eye (with its blurred edge just as we see it), the shadow area looks right. Now add the value of the legs, feet, post, etc. Seeing shapes of relative value, not detail, is the key.

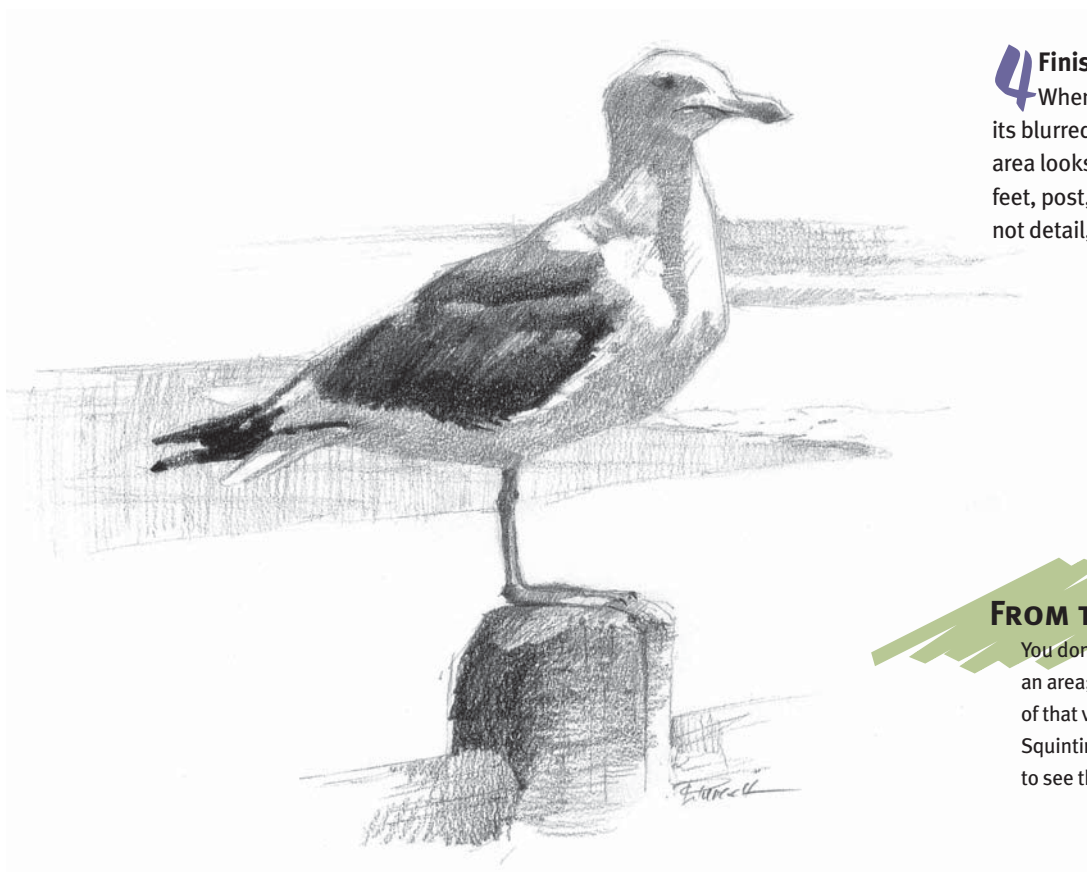

FROM THE ARTIST'S BRAIN

You don't squint to see the exact value of an area; you squint to see the relationship of that value to the value adjacent shapes. Squinting eliminates details and allows you to see the bigger shapes of value.

Methods of rendering value

The method you choose to create values using a graphite pencil is your choice. Some prefer crosshatching, some prefer to blend, and some (myself included) prefer to create the value with strokes that also define the shape. This latter technique is called broad-stroke.

For the bulk of my drawing, I like the directness of adjusting the pressure of the pencil to achieve the right value. It's similar to allowing paint strokes to become part of the

finished work instead of blending them perfectly.

Getting the value relationships right is far more important than the method you choose. But, so you can see how these methods appear in a finished drawing, I've done the same drawing three times, each employing a different method. In all three, the darkest and lightest areas are the same as well as the relationship of grays. Only the technique differs.

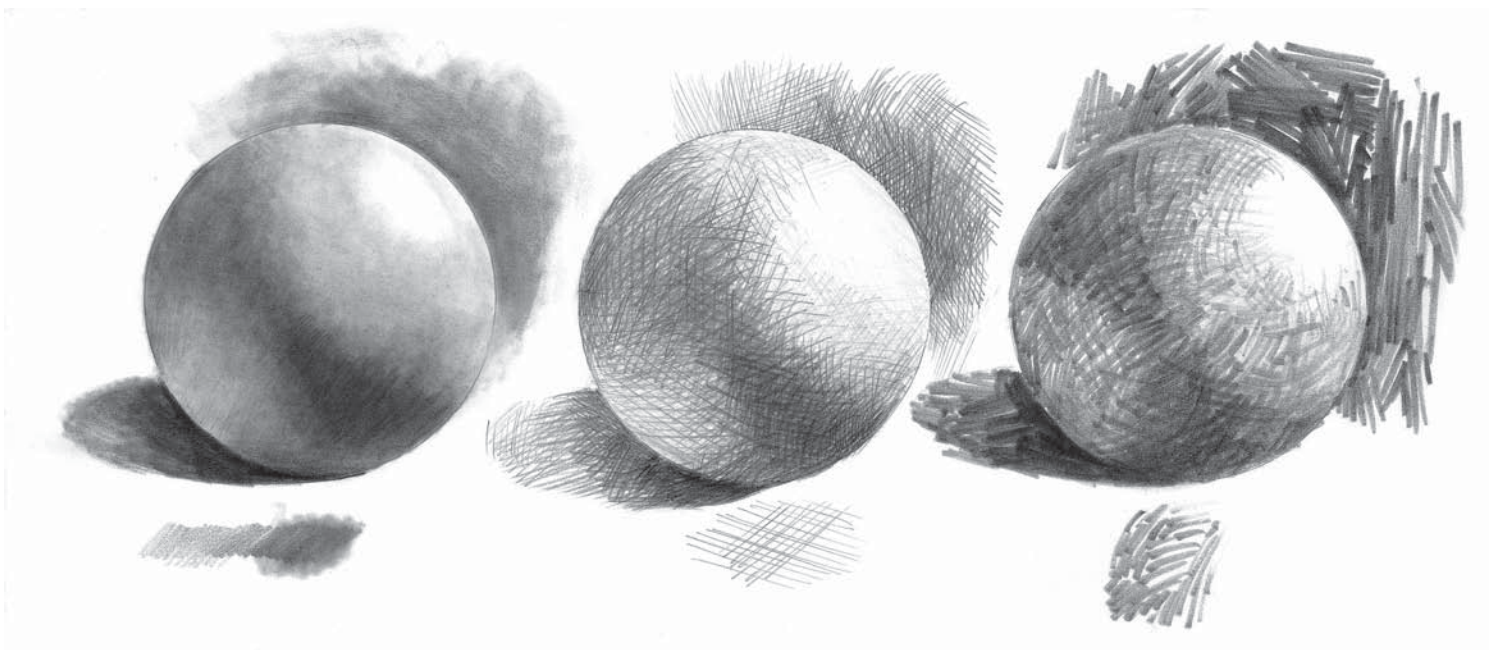

Blending

Graphite can be blended and rubbed to achieve a nearly photographic effect. In this drawing, I used a 2B pencil for the darker areas and an HB pencil to lay down the lighter values. I then went over the strokes with a blending stump.

Crosshatching

Cross-hatching is a series of straight parallel lines, overlaid by more lines running in opposing directions. These are built up gradually to achieve gradations of tone. Cross-hatching should be used for gradations in tone, not to establish the shape of the rounded form.

Broad-stroke

This stroke differs from cross-hatching in two ways. Instead of using a sharpened point, the end of the graphite is sanded down at an angle to create a chisel point. Also, the strokes follow the plane and vary in length. This is my personal favorite for use in my sketchbook because it's fast and re-enforces the planes in the subject.



Blended Graphite Method

CLOVELLY DRY DOCK I

HB & 2B Graphite pencil, 9" x 12" (23cm x 30cm)



Crosshatching Technique

CLOVELLY DRY DOCK II

0.5 mm graphite pencil, 9" x 12" (23cm x 30cm)



Broad-stroke Method

CLOVELLY DRY DOCK III

6B graphite pencil, 9" x 12" (23cm x 30cm)

MORE RESOURCES

Subscribe to *The Artist's Magazine*



[CLICK HERE](#)

Subscribe to *Drawing*



[CLICK HERE](#)

CONNECT WITH US

